

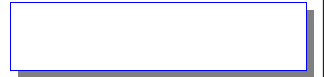

ELECTRONICS



TO :

DATE : 11. Oct. 2006

**SAMSUNG TFT-LCD**

**MODEL NO. : LTV250QV-F0B**

Customer Approval

\_\_\_\_\_  
\_\_\_\_\_  
\_\_\_\_\_  
\_\_\_\_\_

*Any Modification of Spec is not allowed without SEC's permission.*

Approved by :           **S. K. HUR**          

**AMLCD BUSINESS**

**Samsung Electronics Co . , LTD.**



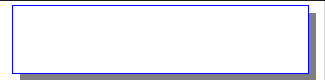

## **Contents**

Revision History	-----	(3)
General Description	-----	(4)
1. Absolute Maximum Ratings	-----	(5)
1.1 Absolute Ratings Of Environment		
1.2 Electrical Absolute Ratings		
2. Optical Characteristics	-----	(7)
3. Electrical Characteristics	-----	(11)
3.1 TFT-LCD Module		
3.2 Back-light Unit		
4. Block Diagram	-----	(13)
4.1 TFT-LCD Module with Back Light Unit		
5. Input Terminal Pin Assignment	-----	(14)
5.1 Input Signal & Power		
5.2 Input Signal, Basic Display Colors and Gray Scale of Each Colors		
6. Operation Specifications	-----	(16)
6.1 Serial Peripheral Interface		
6.2 Data Format for 18bit RGB Interface		
6.3 18bit RGB Interface Timing		
6.4 Electrical Specifications		
7. Command List & Instruction Descriptions	-----	(21)
7.1 Command List		
7.2 Instruction Descriptions		
8. Reset	-----	(21)
9. Power On/Off Sequence	-----	(22)
9.1 Power On Sequence		
9.2 Power Off Sequence		
10. Part List of Components	-----	(25)
10.1 Panel, Driver IC		
11. FPC Circuit Diagram	-----	(26)
12. Out Dimension	-----	(27)
13. Packing	-----	(28)
14. Marking & Others	-----	(29)
15. General Precaution	-----	(30)
15.1 Handling		
15.2 Storage		
15.3 Operation		
15.4 Others		

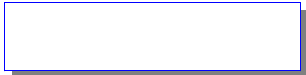

### Revision History

Date	Rev. No.	Page	Summary
Oct. 10. 2006	000		Preliminary Rev.000 was issued.

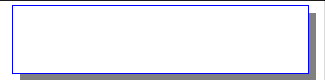

## General Description

### \* Description

LTV250QV-F0B is a TMR(Transmissive with Micro Reflective) type color active matrix TFT (Thin Film Transistor) liquid crystal display (LCD) that uses amorphous silicon TFT as a switching devices. This model is composed of a TFT-LCD module, a driver circuit and a back-light unit. The resolution of a 2.5" contains 320RGBx240 dots and can display up to 16.7M colors.

### \* Features

- Transmissive with Micro Reflective type and back-light with 4 LEDs are available.
- Visible in outdoor & back-light off condition with reflectivity.
- TN(Twisted Nematic) mode.
- Line inversion mode with stripe type.
- 8bit RGB Interface + Serial Peripheral Interface(SPI)
- SYNC(Vsync, Hsync, Dotclk) mode
- Gate Driver IC embeded on Panel(Double ASG)

### \* Applications

- Display terminals for DSC(Digital Still Camera), PMP(Portable Multimedia Player) application products.

### \* General information

Items	Specification	Unit	Note
Display area	50.88(H) x 38.04(V)	mm	-
Driver element	a-Si TFT active matrix	-	-
Display colors	16.7M	colors	-
Number of pixels	320RGB(H) x 240(V)	dot	-
Pixel arrangement	stripe type	-	-
Pixel pitch	0.159 (H) x 0.1585 (V)	mm	-
Display mode	Normally White	-	-
Viewing direction	6	o'clock	-

### \* Mechanical information

Item		Min.	Typ.	Max.	Unit	Note
Module size	Horizontal(H)	56.78	56.98	57.18	mm	-
	Vertical(V)	47.74	47.94	48.14	mm	(1)
	Depth(D)	2.46	2.66	2.86	mm	(1)
Weight		-	16.0		g	-

Note (1) Not include FPC

Refer to the Outline Dimension in the "12.Outline Dimension" for further information.

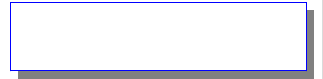

# 1. Absolute Maximum Ratings

## 1.1 Absolute Ratings of Environment

Item	Symbol	Min.	Max.	Unit	Note
Storage temperature	T <sub>STG</sub>	-30	70	°C	(1)
Operating temperature (Ambient temperature)	T <sub>OPR</sub>	-20	60	°C	(1),(2)

Note (1) 95 % RH Max. ( 40 °C Ta )

Maximum wet-bulb temperature at 39 °C or less. (Ta > 40 °C) No condensation.

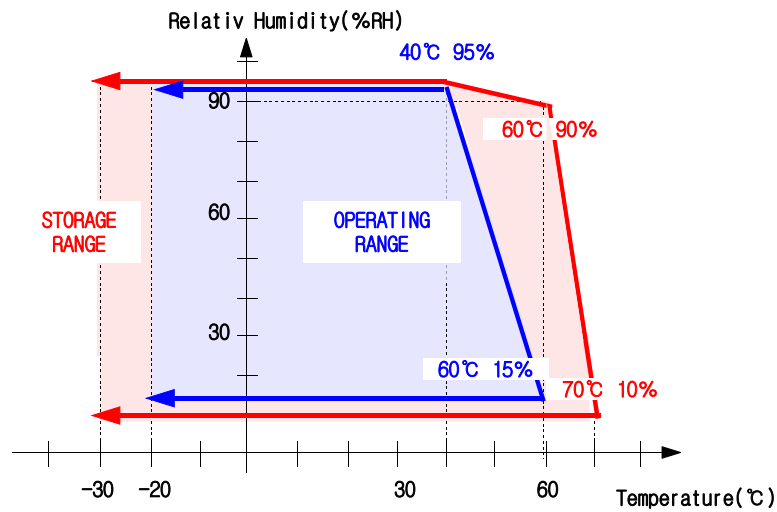

(2) In case of below 0°, the response time of liquid crystal (LC) becomes slower and the color of panel becomes darker than normal one.

Level of retardation depends on temperature, because of LC's characteristics.

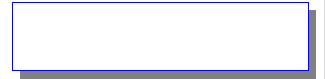

## 1.2 Electrical Absolute Ratings

### (1) TFT-LCD Module

(Ta = 25 ± 2°C, V<sub>SS</sub>=GND=0)

Characteristics	Symbol	Min.	Max.	Unit	Note
Digital supply voltage	V <sub>CC</sub>	-0.3	+5.0	V	-
Analog supply voltage	DDVDH	-0.3	+7.0	V	-

### (2) Back-Light Unit

(Ta = 25 ± 2°C)

Item	Symbol	Min.	Max.	Unit.	Note
Current	I <sub>B</sub>		25	mA	(1)

Note (1) Permanent damage to the device may occur if maximum values are exceeded or reverse voltage is loaded.

Functional operation should be restricted to the conditions described under normal operating conditions.

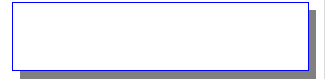

## . Optical Characteristics

The following items are measured under stable conditions. The optical characteristics should be

measured in a dark room or equivalent state with the methods shown in Note (1).

Measuring equipment: LCD-5000, BM-5A, BM-7, PR-650, EZ-Contrast

(Ta = 25 ± 2°C, V<sub>CC</sub> = V<sub>Cl</sub> = 3.3V, I<sub>B</sub> = 15mA)

Item	Symbol	Condition	Min.	Typ.	Max.	Unit	Note	
Contrast ratio (Center point)	C/R		T.B.D	T.B.D		-	(2) BM-5A	
Luminance of white (Center point)	YL	NOTE (1)		T.B.D		cd/m <sup>2</sup>	(3) BM-5A	
Response time	Rising:Tr	Tr+Tf	f = 0	25	30	msec	(4) BM-7	
	Falling:Tf							
Color chromaticity (CIE 1931)	White	Wx	q = 0	0.24	0.29	0.34	-	(5) PR-650
		Wy	Normal	0.28	0.33	0.38		
	Red	Rx	Viewing Angle	0.58	0.63	0.68		
		Ry		0.28	0.33	0.38		
	Green	Gx	B/L On	0.28	0.33	0.38		
		Gy		0.51	0.56	0.61		
	Blue	Bx	0.09	0.14	0.19			
		By	0.08	0.13	0.18			
Viewing angle	Hor.	qL		60	80	Degree s	(6) Ez- Contrast	
		qR	C/R <sup>3</sup> 10	60	80			
	Ver.	fH	B/L On	60	80			
		fL	40	65				

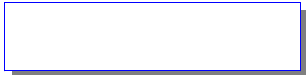

Note (1) Test Equipment Setup

After stabilizing and leaving the panel alone at a given temperature for 30 min , the measurement should be executed. Measurement should be executed in a stable, windless, and dark room. 30 min after lighting the back-light. This should be measured in the center of screen.

Environment condition :  $T_a = 25 \pm 2 \text{ }^\circ\text{C}$

Back-Light On condition

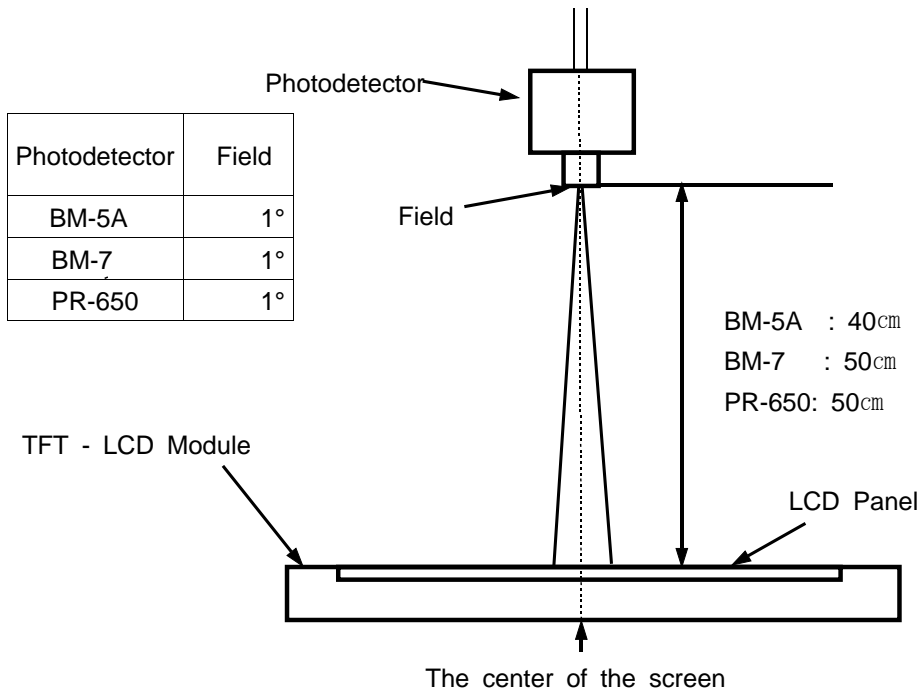

Back-Light Off condition

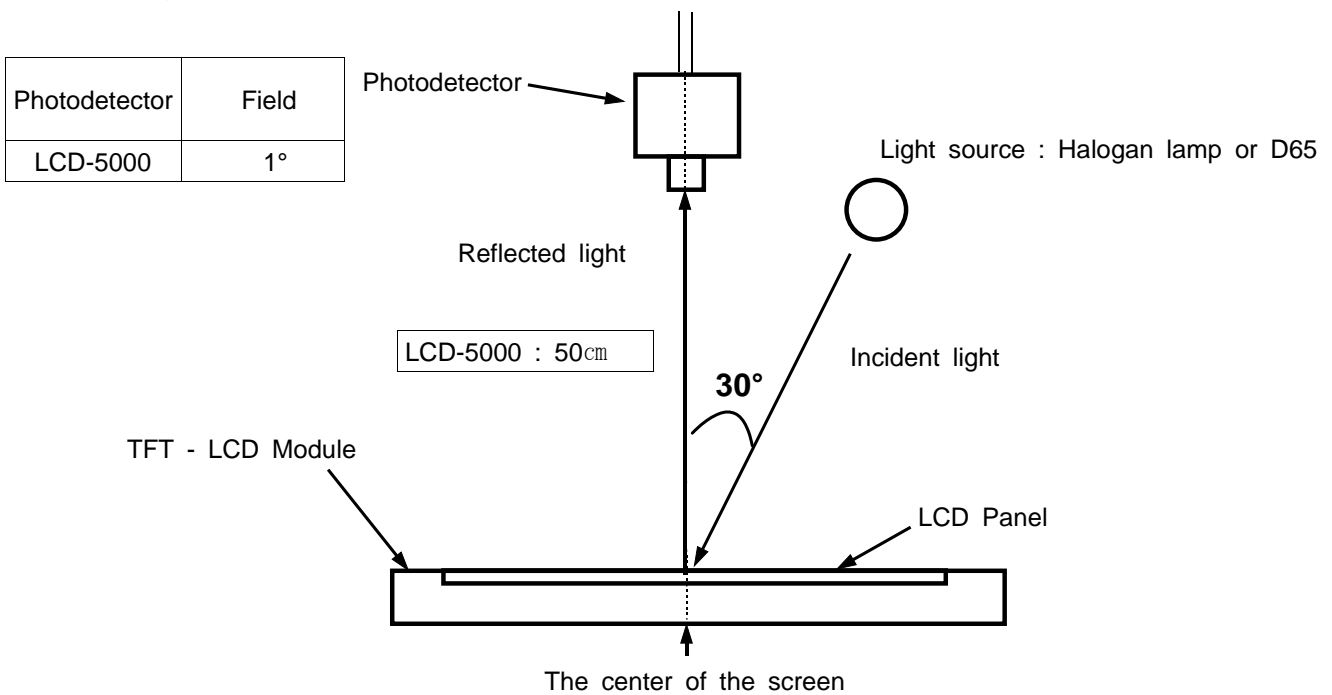

Optical Measuring Equipment Setup



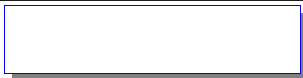

Note (2) Definition of Contrast Ratio (C/R) : Ratio of gray max (Gmax) & gray min (Gmin) at the center point

$$CR = \frac{G_{max}}{G_{min}}$$

\* Gmax : Luminance with all pixels white

\* Gmin : Luminance with all pixels black

Note (3) Definition of Luminance of White : Luminance of white at the center point

Note (4) Definition of Response time : Sum of Tr ,Tf

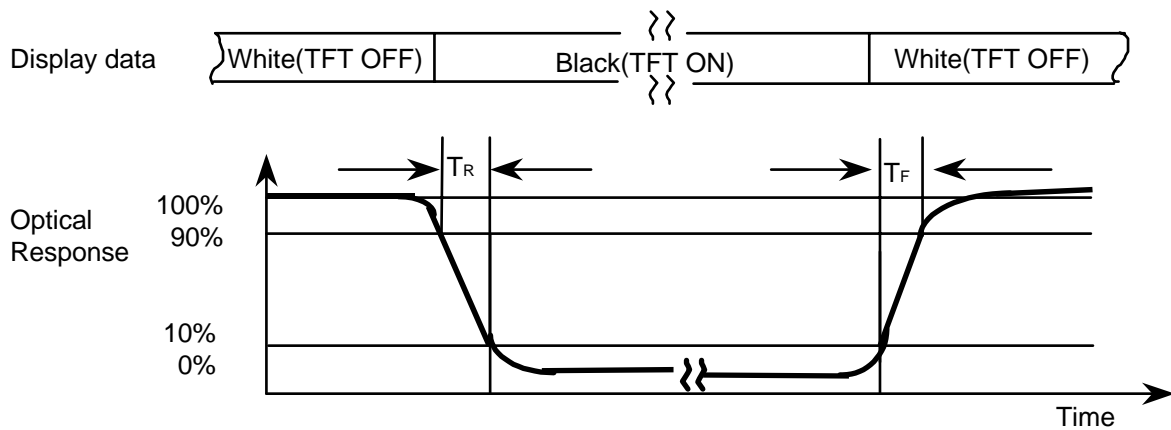

Note (5) Definition of Color Chromaticity (CIE 1931)

Color coordinate of white & red, green, blue at center point.

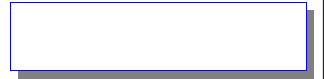

Note (7) Definition of Viewing Angle : Viewing angle range ( $CR \geq 10$  )

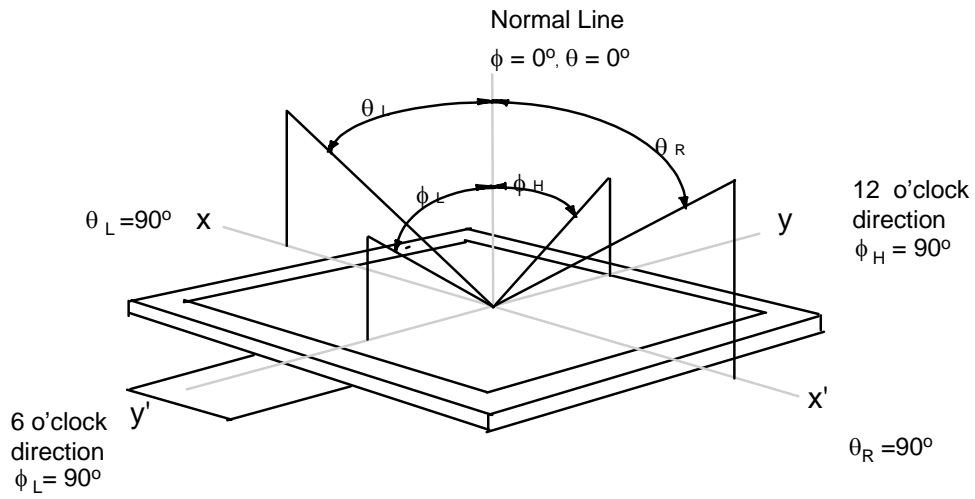

### 3. Electrical Characteristics

#### 3.1 TFT-LCD Module

$T_a = 25 \pm 2^\circ\text{C}$

Characteristics		Symbol	Min.	Typ.	Max.	Unit	Note
Digital supply voltage		$V_{CC}$	2.5	3.0	3.3	V	-
Analog supply voltage		DDVDH	4.85	5.0	5.15	V	-
Gate On voltage		$V_{GH}$	17.5	18.0	18.5	V	-
Gate Off voltage		$V_{GL}$	-10.5	-10	-9.5	V	-
Power Dissipation	Full	$P_{FULL}$		40		mW	-
Frame frequency		$f_{Frame}$		-	90	Hz	-
Dot Clock		DOTCLK	-	-	30.0	MHz	-
Serial Clock		SCL	-	-	10.0	MHz	-

\* To prevent a latch-up or DC operation of the LCD module, the power on/off sequence should be as the Chapter 9. Power On/Off Sequence.

\*  $|V_{GH} - 0.7 \cdot |V_{GL}|| \text{ MAX} = 25.0\text{V}$

\* Keep  $|0.7 \cdot |V_{GL}| - V_{GL}|$  greater than or equal to 3.0V when  $|V_{GH} - 0.7 \cdot |V_{GL}|| = 25.0\text{V}$

- Power On :  $V_{CC} \rightarrow V_{GL} \rightarrow \text{DDVDH} \rightarrow V_{GH} \rightarrow \text{Data}$
- Power Off :  $\text{Data} \rightarrow V_{GH} \rightarrow \text{DDVDH} \rightarrow V_{GL} \rightarrow V_{CC}$

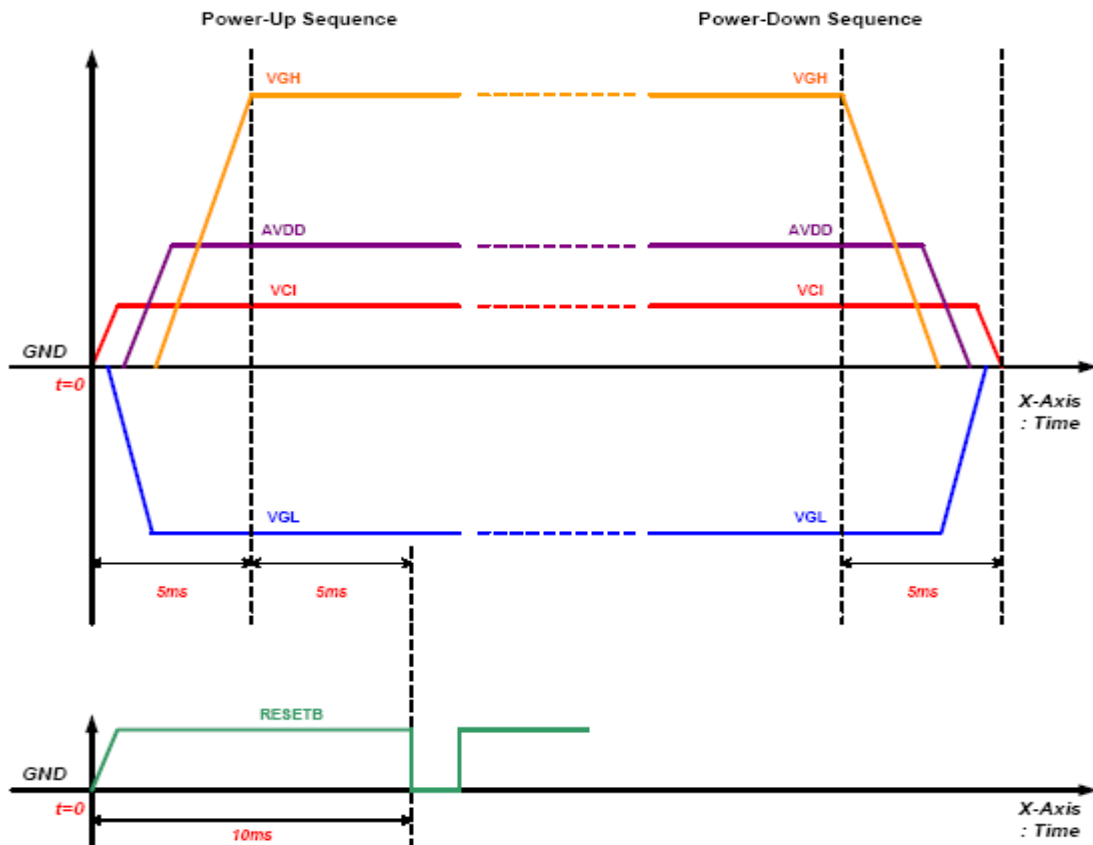

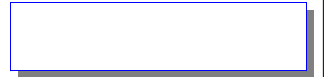

#2. Dissipation current check pattern

▶ 0 Gray black pattern

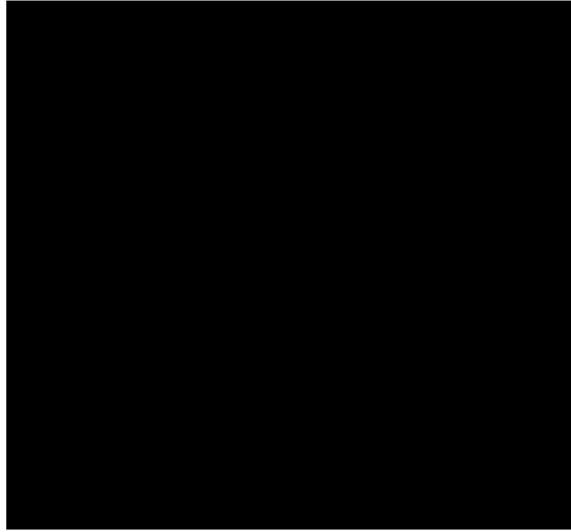

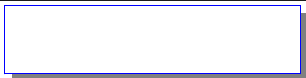

### 3.2 Back-Light unit

The back-light system is an edge-lighting type with 4 white LED(Light Emitting Diode)s.

(Ta=25 ± 2°C)

Item	Symbol	Min.	Typ.	Max.	Unit	Note
Current	I <sub>B</sub>	10	15	25	mA	(1)
Power Consumption	P <sub>BL</sub>	-	200	-	mW	(2)

Note (1) 4 LEDs serial type.

(2) Where I<sub>B</sub> = 15mA, V<sub>B</sub> = P<sub>BL</sub> / I<sub>B</sub>

## 4. Block Diagram

### 4.1 TFT-LCD Module (Interface System Structure) with Back Light Unit

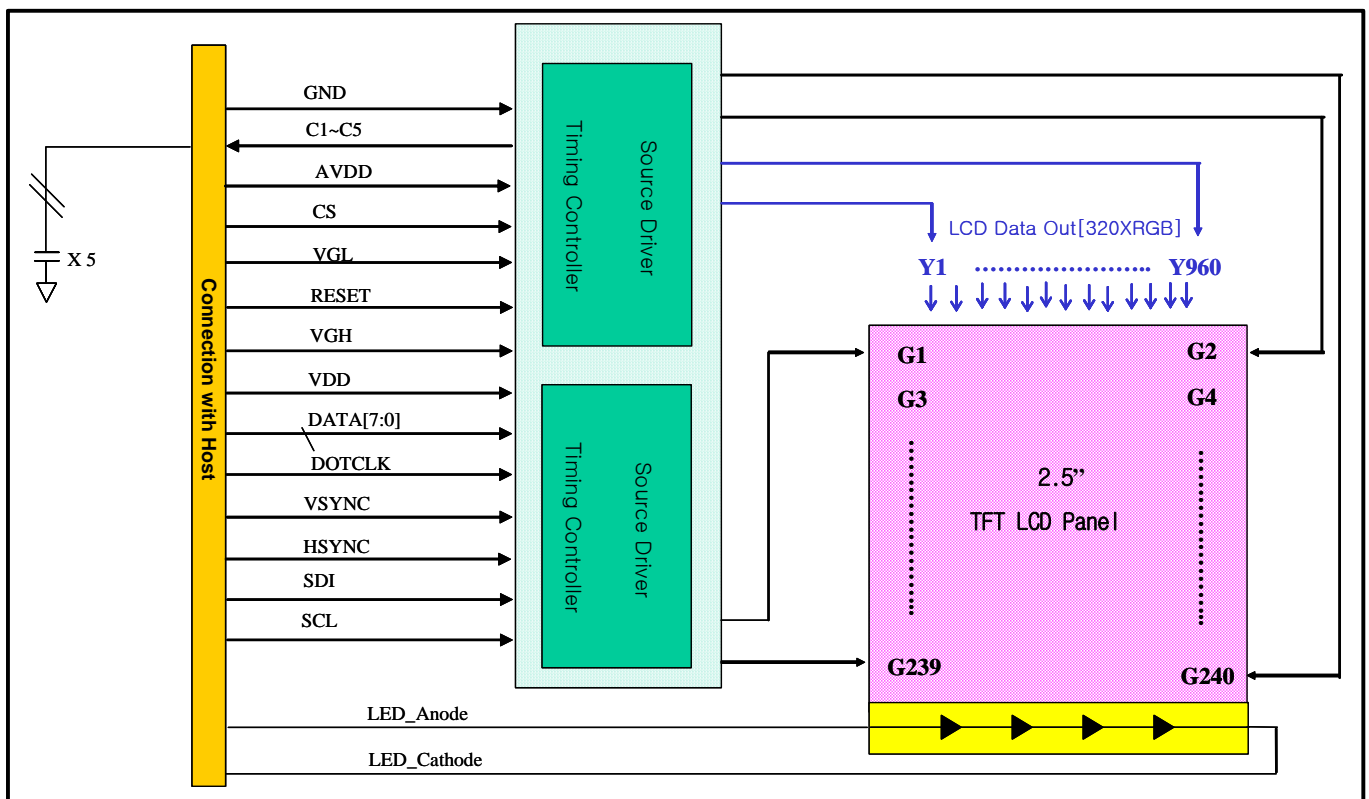

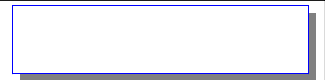

## 5. Input Terminal Pin Assignment

### 5.1 Input Signal & Power (Connector type : 31Pin / 0.3mm pitch / Bottom contact)

Pin No	Symbol	Description	Input/Output	Note
1	LED_Cathode	LED_Cathode	Input	
2	LED_Anode	LED_Anode	Input	
3	/RESET	/RESET	Input	
4	/CS	Chip Select	Input	
5	SCL	Serial Clock	Input	
6	SDI	Serial Data Input	Input	
7	DATA0	Graphic Data 0	Input	
8	DATA1	Graphic Data 1	Input	
9	DATA2	Graphic Data 2	Input	
10	DATA3	Graphic Data 3	Input	
11	DATA4	Graphic Data 4	Input	
12	DATA5	Graphic Data 5	Input	
13	DATA6	Graphic Data 6	Input	
14	DATA7	Graphic Data 7	Input	
15	HSYNC	Horizontal Synchronous Signal	Input	
16	VSYNC	Vertical Synchronous Signal	Input	
17	DOTCLK	Data Clock	Input	
18	AVDD	Vanalog voltage	Input	
19	AVDD	Vanalog voltage	Input	
20	VDD	Vdigital voltage	Input	
21	VDD	Vdigital voltage	Input	
22	C5	Connect Capacitor(10 $\mu$ F)	-	
23	C4	Connect Capacitor(10 $\mu$ F)	-	
24	VGL	Vgoff voltage	Input	
25	VGL	Vgoff voltage	Input	
26	C3	Connect Capacitor(10 $\mu$ F)	-	
27	VGH	Vgon voltage	Input	
28	C2	Connect Capacitor(10 $\mu$ F)	-	
29	C1	Connect Capacitor(10 $\mu$ F)	-	
30	GND	Ground	GND	
31	GND	Ground	GND	



### 5.2 Input Signal, Basic Display Colors and Gray Scale of Each Colors

COLOR	DISPLAY	DATA SIGNAL																				GRAY SCALE LEVEL				
		RED							GREEN							BLUE										
		R0	R1	R2	R3	R4	R5	R6	R7	G0	G1	G2	G3	G4	G5	G6	G7	B0	B1	B2	B3		B4	B5	B6	B7
BASIC COLOR	BLACK	0	0	0	0	0	0	0	0	0	0	0	0	0	0	0	0	0	0	0	0	0	0	0	0	-
	BLUE	0	0	0	0	0	0	0	0	0	0	0	0	0	0	0	0	1	1	1	1	1	1	1	1	-
	GREEN	0	0	0	0	0	0	0	0	1	1	1	1	1	1	1	1	0	0	0	0	0	0	0	0	-
	CYAN	0	0	0	0	0	0	0	0	1	1	1	1	1	1	1	1	1	1	1	1	1	1	1	1	-
	RED	1	1	1	1	1	1	1	1	0	0	0	0	0	0	0	0	0	0	0	0	0	0	0	0	-
	MAGENTA	1	1	1	1	1	1	1	1	0	0	0	0	0	0	0	0	1	1	1	1	1	1	1	1	-
	YELLOW	1	1	1	1	1	1	1	1	1	1	1	1	1	1	1	1	0	0	0	0	0	0	0	0	-
	WHITE	1	1	1	1	1	1	1	1	1	1	1	1	1	1	1	1	1	1	1	1	1	1	1	1	-
GRAY SCALE OF RED	BLACK	0	0	0	0	0	0	0	0	0	0	0	0	0	0	0	0	0	0	0	0	0	0	0	R0	
	DARK ↑	1	0	0	0	0	0	0	0	0	0	0	0	0	0	0	0	0	0	0	0	0	0	0	R1	
		0	1	0	0	0	0	0	0	0	0	0	0	0	0	0	0	0	0	0	0	0	0	0	R2	
		:	:	:	:	:	:	:	:	:	:	:	:	:	:	:	:	:	:	:	:	:	:	:	:	R3~R252
		:	:	:	:	:	:	:	:	:	:	:	:	:	:	:	:	:	:	:	:	:	:	:	:	
	LIGHT ↓	1	0	1	1	1	1	1	1	0	0	0	0	0	0	0	0	0	0	0	0	0	0	0	R253	
		0	1	1	1	1	1	1	1	0	0	0	0	0	0	0	0	0	0	0	0	0	0	0	R254	
	RED	1	1	1	1	1	1	1	1	0	0	0	0	0	0	0	0	0	0	0	0	0	0	0	R255	
GRAY SCALE OF GREEN	BLACK	0	0	0	0	0	0	0	0	0	0	0	0	0	0	0	0	0	0	0	0	0	0	0	G0	
	DARK ↑	0	0	0	0	0	0	0	0	1	0	0	0	0	0	0	0	0	0	0	0	0	0	0	G1	
		0	0	0	0	0	0	0	0	0	1	0	0	0	0	0	0	0	0	0	0	0	0	0	G2	
		:	:	:	:	:	:	:	:	:	:	:	:	:	:	:	:	:	:	:	:	:	:	:	G3~G252	
		:	:	:	:	:	:	:	:	:	:	:	:	:	:	:	:	:	:	:	:	:	:	:		:
	LIGHT ↓	0	0	0	0	0	0	0	0	1	0	1	1	1	1	1	1	0	0	0	0	0	0	0	G253	
		0	0	0	0	0	0	0	0	0	1	1	1	1	1	1	1	0	0	0	0	0	0	0	G254	
	GREEN	0	0	0	0	0	0	0	0	1	1	1	1	1	1	1	1	0	0	0	0	0	0	0	G255	
GRAY SCALE OF BLUE	BLACK	0	0	0	0	0	0	0	0	0	0	0	0	0	0	0	0	0	0	0	0	0	0	0	B0	
	DARK ↑	0	0	0	0	0	0	0	0	0	0	0	0	0	0	0	0	1	0	0	0	0	0	0	B1	
		0	0	0	0	0	0	0	0	0	0	0	0	0	0	0	0	0	1	0	0	0	0	0	B2	
		:	:	:	:	:	:	:	:	:	:	:	:	:	:	:	:	:	:	:	:	:	:	:	B3~B60	
		:	:	:	:	:	:	:	:	:	:	:	:	:	:	:	:	:	:	:	:	:	:	:		:
	LIGHT ↓	0	0	0	0	0	0	0	0	0	0	0	0	0	0	0	0	1	0	1	1	1	1	1	B61	
		0	0	0	0	0	0	0	0	0	0	0	0	0	0	0	0	0	1	1	1	1	1	1	B62	
	BLUE	0	0	0	0	0	0	0	0	0	0	0	0	0	0	0	0	1	1	1	1	1	1	1	B63	

Note) Definition of Gray :

Rn : Red Gray, Gn : Green Gray, Bn : Blue Gray (n = Gray level)

Input Signal : 0 = Low level voltage, 1 = High level voltage



## 6. Operation Specifications

### 6.1 Serial Peripheral Interface

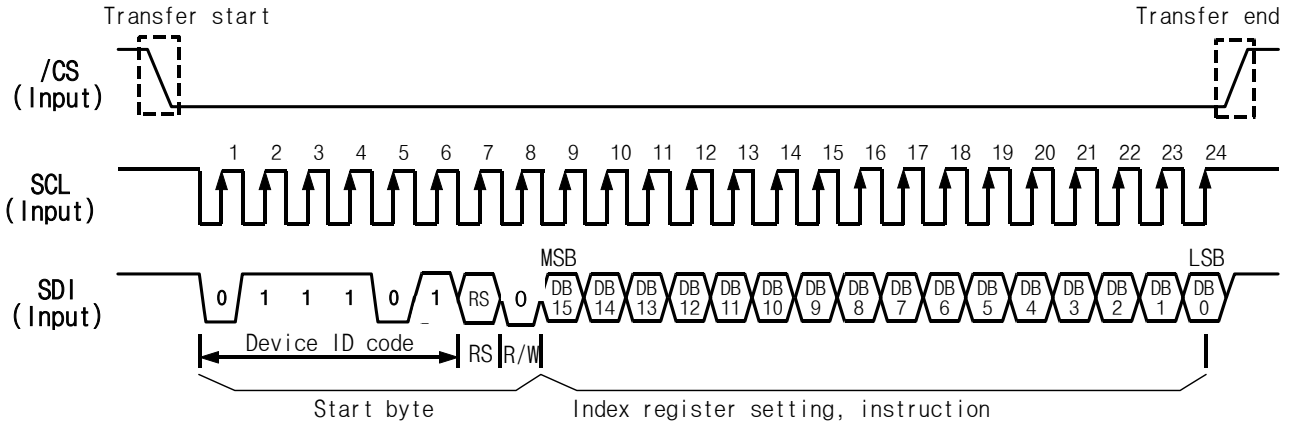

(Note) RS="0": Index data  
 RS="1": Instruction data

### 6.2 Data Format for 8bit RGB Interface

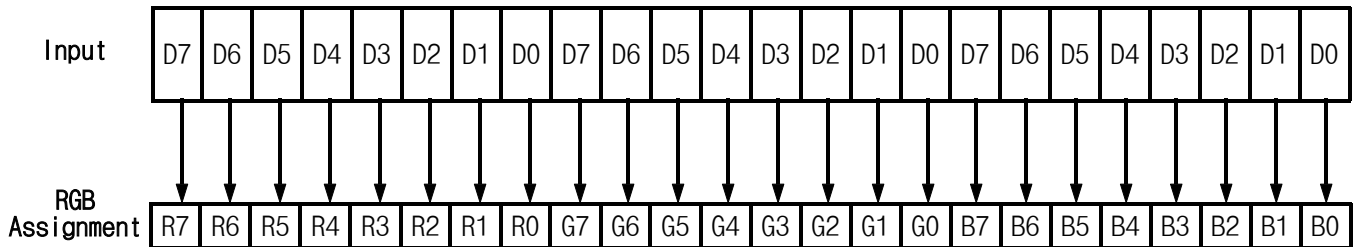



### 6.3 8bit RGB Interface Timing

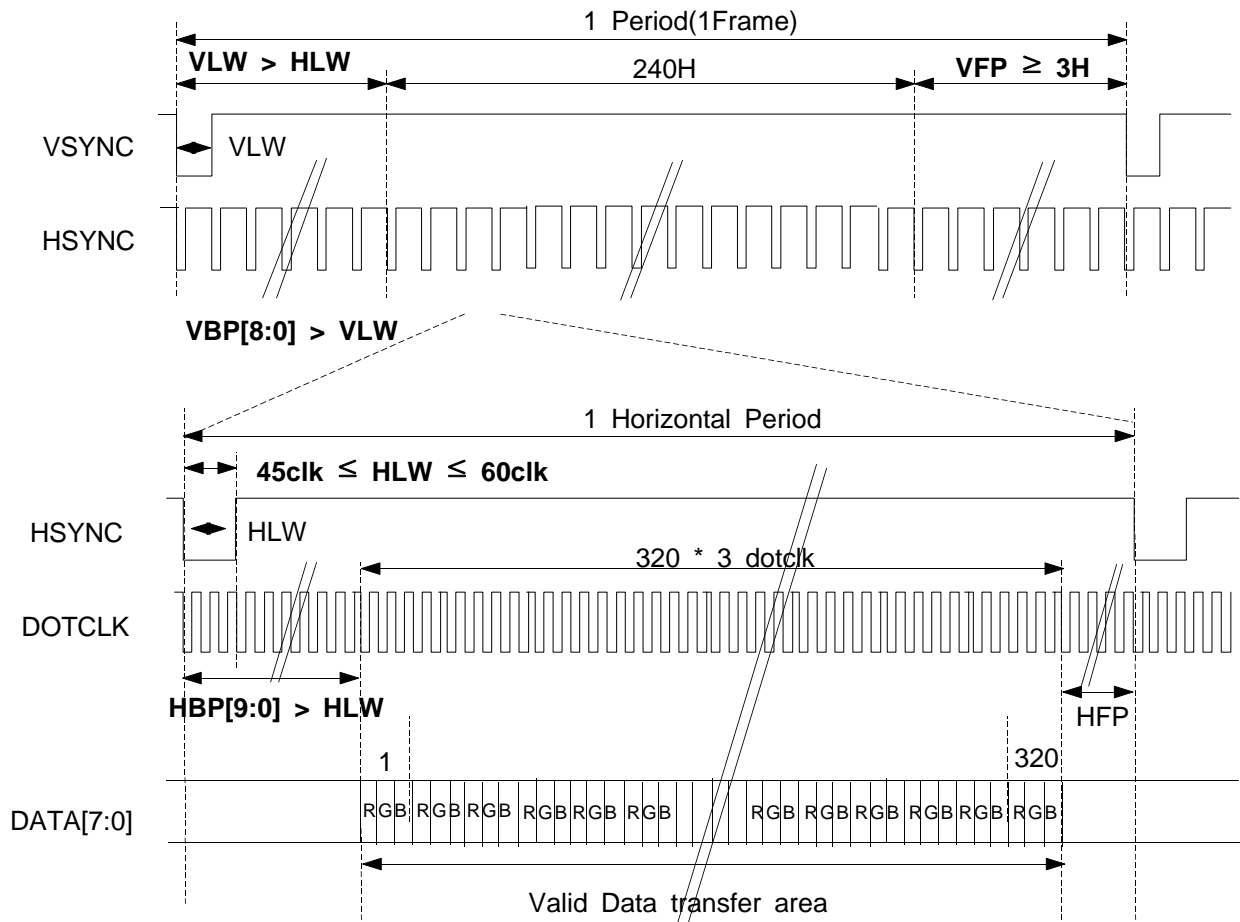

- \*  $DOTCLK = f_{frame} \times (240 + VBP + VFP) \times (320 \times 3 + HBP + HFP)$
- \*  $3H \leq VFP$
- \*  $HBP > HLW$
- \*  $VBP > VLW$
- \*  $45clk \leq HLW \leq 60clk$
- \*  $VLW > HLW$

Note 1. Polarity register setting : VPL = 0, HPL = 0, DPL=0  
 2. The rising edge of DOTCLK is used to fetch display data

## 6.4 Electrical Specifications

### a. RGB Data Interface Characteristics

( $T_A = -40$  to  $+85$  °C)

Characteristic	Symbol	8bit RGB Interface		Unit
		Min	Max	
DOTCLK cycle time	tDCYC	30	-	ns
DOTCLK rise/fall time	tR,tF	-	2	
DOTCLK Pulse width high	tDCHW	15	-	
DOTCLK Pulse width low	tDCLW	15	-	
Sync Setup time	tSYS	10	-	
Sync Hold time	tSYH	10	-	
PD data setup time	tPDS	15	-	
PD data hold time	tPDH	15	-	

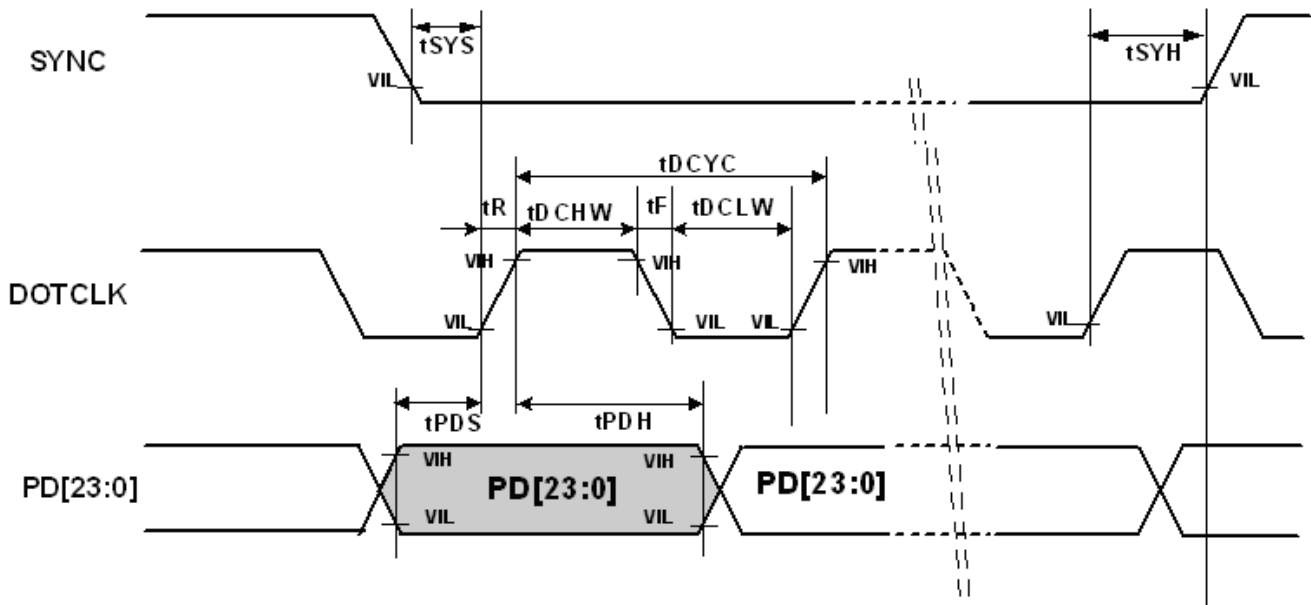

### AC Characteristics

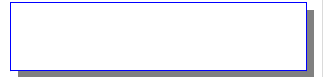

## b. Clock Synchronized Serial Mode Characteristics

( $T_A = -40$  to  $+85$  °C)

Characteristic	Symbol	Min	Max	Unit
Serial clock cycle time	tscyc	100	-	ns
Serial clock rise/fall time	tR,tF	-	2	
Pulse width high for write	tSCHW	30	-	
Pulse width high for read	tSCHR	50	-	
Pulse width low for write	tSCLW	30	-	
Pulse width low for read	tSCLR	50	-	
Chip Select setup time	tCSS	20	-	
Chip Select hold time	tCSH	50	-	
Serial input data setup time	tSIDS	30	-	
Serial input data hold time	tSIDH	30	-	
Serial output data delay time	tSODD	-	100	
Serial output data hold time	tSODH	5	-	

## c. Reset Timing Characteristics

( $T_A = -40$  to  $+85$  °C)

Characteristic	Symbol	Min	Max	Unit
Reset low pulse width	tRES	3*	-	us

\*NOTE. Reset low pulse width shorter than 1us do not make reset. It means undesired short pulse such as glitch, bouncing noise or electrostatic discharge do not cause irregular system reset. Please refer to the table below.

tRES Pulse	Action
Shorter than 1 us	No reset
Longer than 3 us	Reset
Between 1 us and 3 us	Not determined

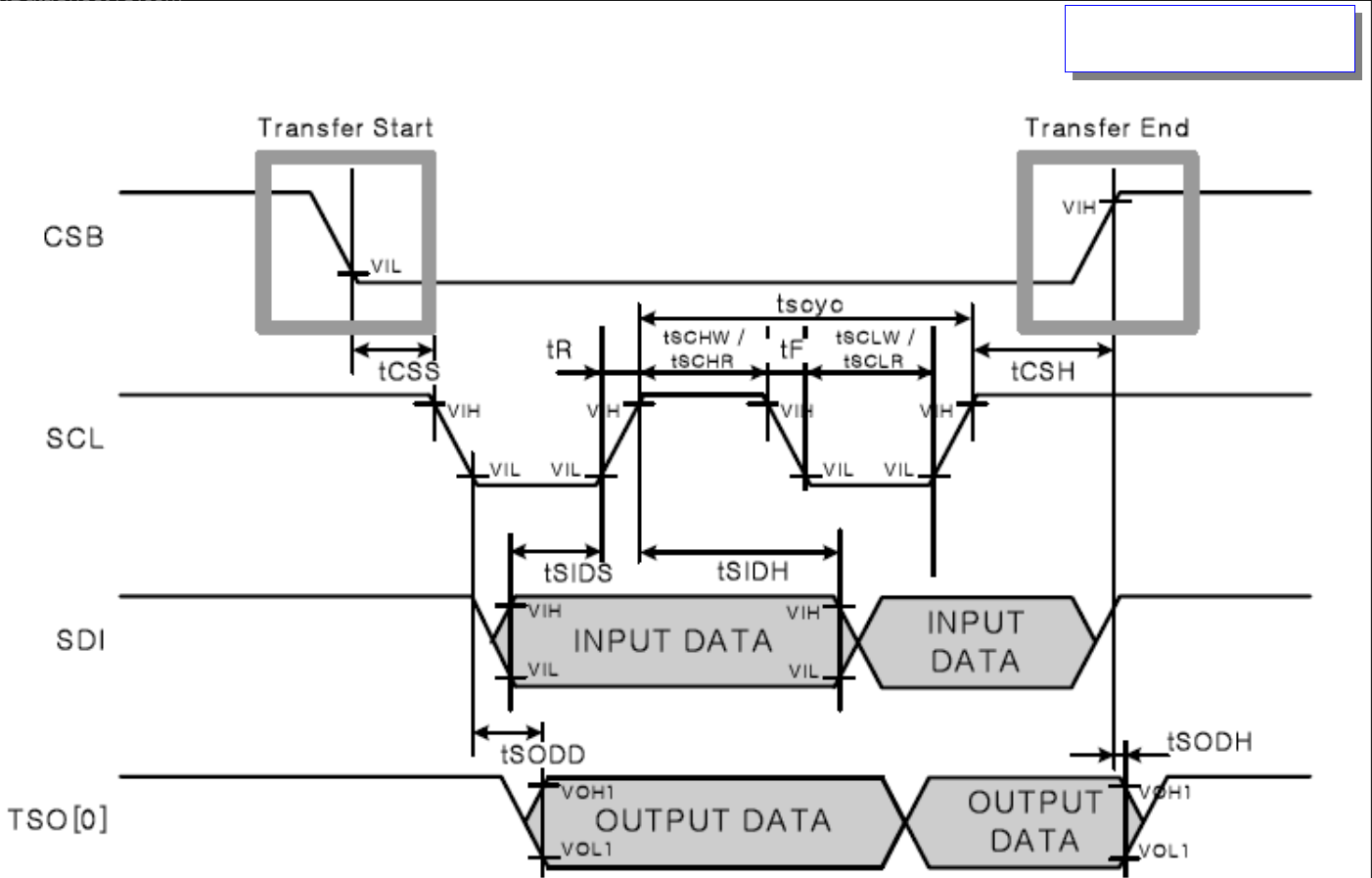

AC Characteristics(SPI Mode)

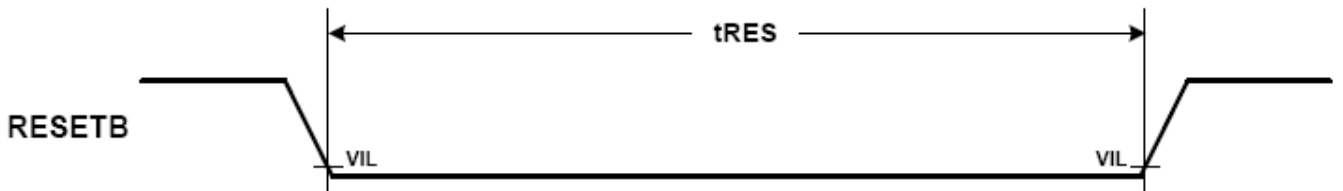

AC Characteristics(RESET timing)

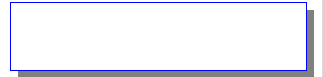

## 7. Command List & Instruction Descriptions

### 7.1 Command List

Refer to the Appendix 1: S6F2002 IC Specification

### 7.2 Instruction Descriptions

Refer to the Appendix 1: S6F2002 IC Specification

## 8. Reset

If the /RESET input becomes "L" or the reset command is input, the each register to its default value. These default values are listed in the table below.

Register		Default	Note
Display Interface Control	R01	001DH	-
Display Data Control	R02	0000H	-
Entry Mode	R03	0000H	-
Gate Control 1	R04	0000H	-
Gate Control 2	R05	0000H	-
Display Control 1	R06	50A3H	-
Display Control 1	R07	0000H	-
Source Output Timing Control	R08	0000H	-
Power Control 1	R09	0000H	-
Power Control 2	R0A	0000H	-
Gamma Control	R10 ~ R19	0000H	-



## 9. Power On/Off Sequence

### 9.1 Power On Sequence

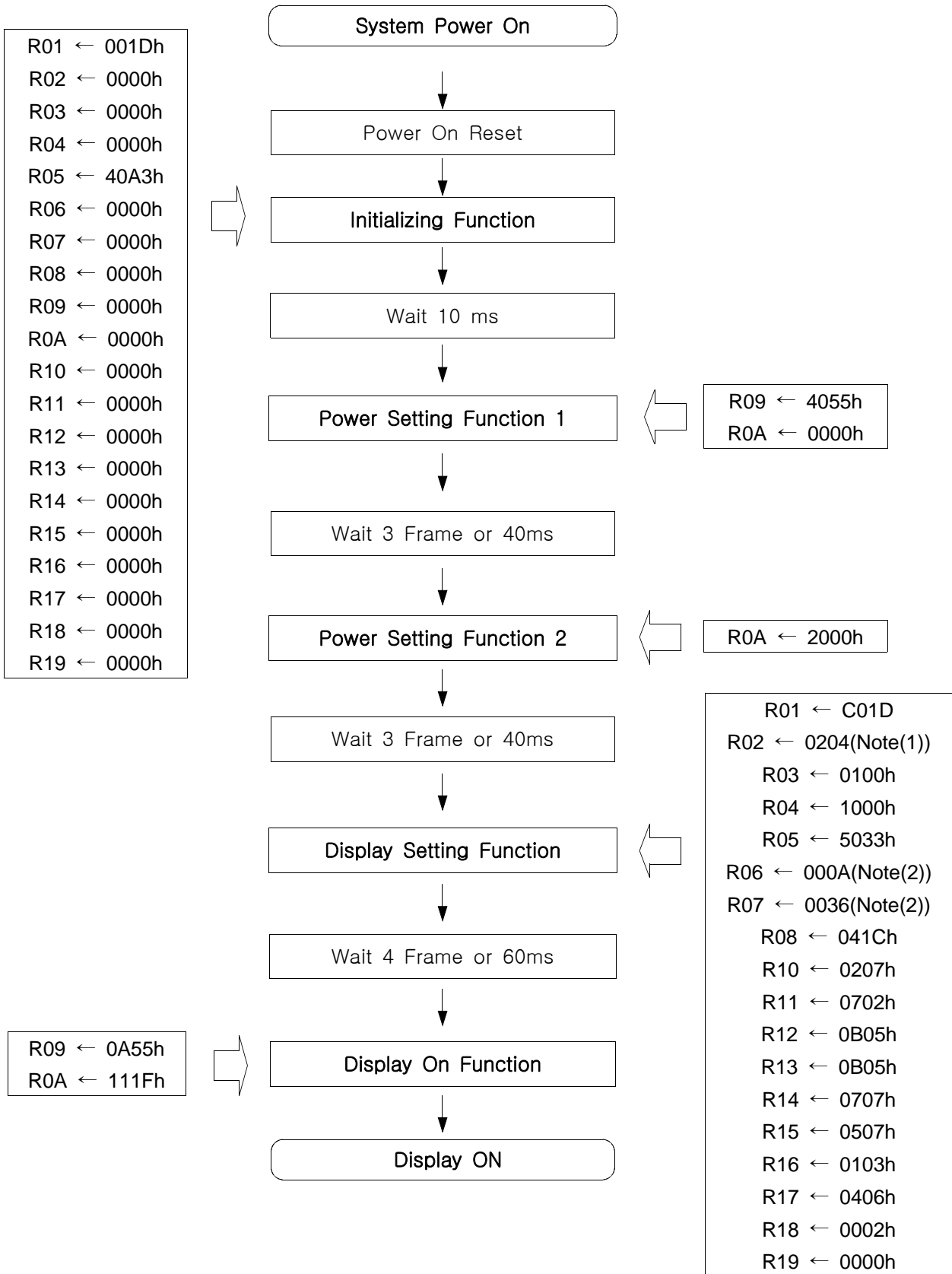

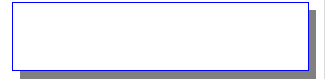

< Note (1) >

- Register 'R02' determines Data format

(R02H)

IB15	IB14	IB13	IB12	IB11	IB10	IB9	IB8	IB7	IB6	IB5	IB4	IB3	IB2	IB1	IB0
0	0	0	0	0	0	1	0	<b>DF1</b>	<b>DF0</b>	0	0	0	1	0	0

- DF Bits Setting

DF1	DF0	Data Format	R02H
0	0	RGB RGB	<b>0204</b>
0	1	RGBX RGBX	<b>0244</b>
1	0	XRGB XRGB	<b>0284</b>
1	1	Setting Inhibited	

< Note (2) >

- Register 'R06', 'R07' determine Vsync Backporch('R06') & Hsync Backporch period('R07')

- Backporch limit

(1) 7clk < Hsync Backporch < 1024clk

(2) 3line < Vsync Backporch < 512line

(R06H)

IB15	IB14	IB13	IB12	IB11	IB10	IB9	IB8	IB7	IB6	IB5	IB4	IB3	IB2	IB1	IB0
0	0	0	0	0	0	0	<b>VBP8</b>	<b>VBP7</b>	<b>VBP6</b>	<b>VBP5</b>	<b>VBP4</b>	<b>VBP3</b>	<b>VBP2</b>	<b>VBP1</b>	<b>VBP0</b>

(R07H)

IB15	IB14	IB13	IB12	IB11	IB10	IB9	IB8	IB7	IB6	IB5	IB4	IB3	IB2	IB1	IB0
0	0	0	0	0	0	0	<b>HBP8</b>	<b>HBP7</b>	<b>HBP6</b>	<b>HBP5</b>	<b>HBP4</b>	<b>HBP3</b>	<b>HBP2</b>	<b>HBP1</b>	<b>HBP0</b>

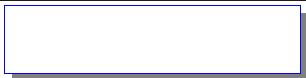

### 9.2 Power Off Sequence

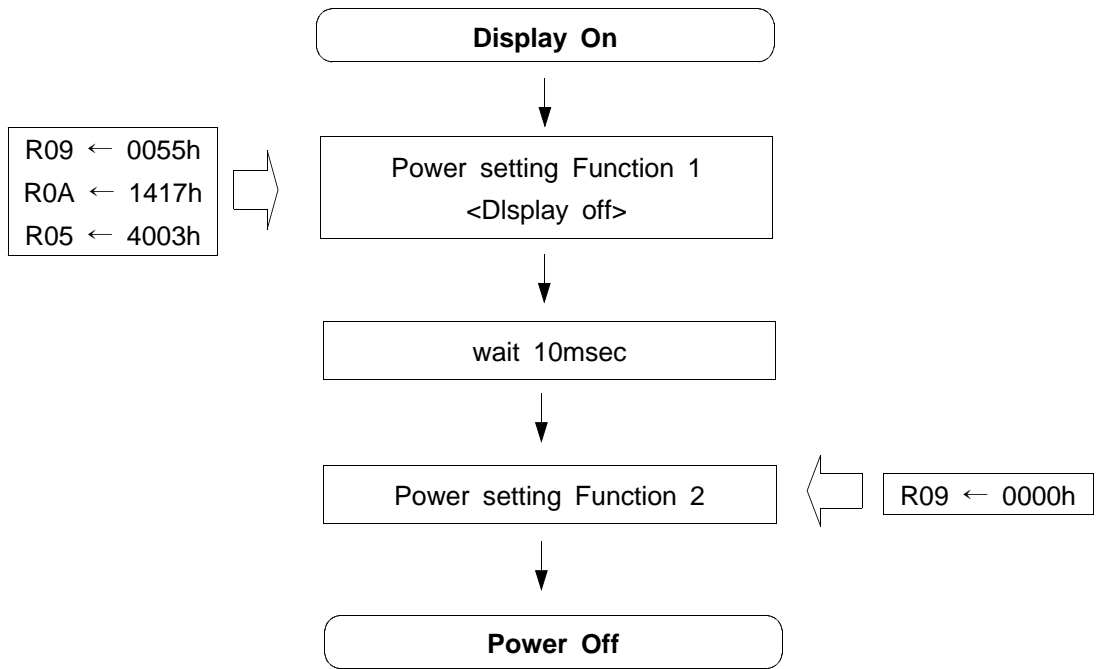







# 11. FPC Circuit Diagram

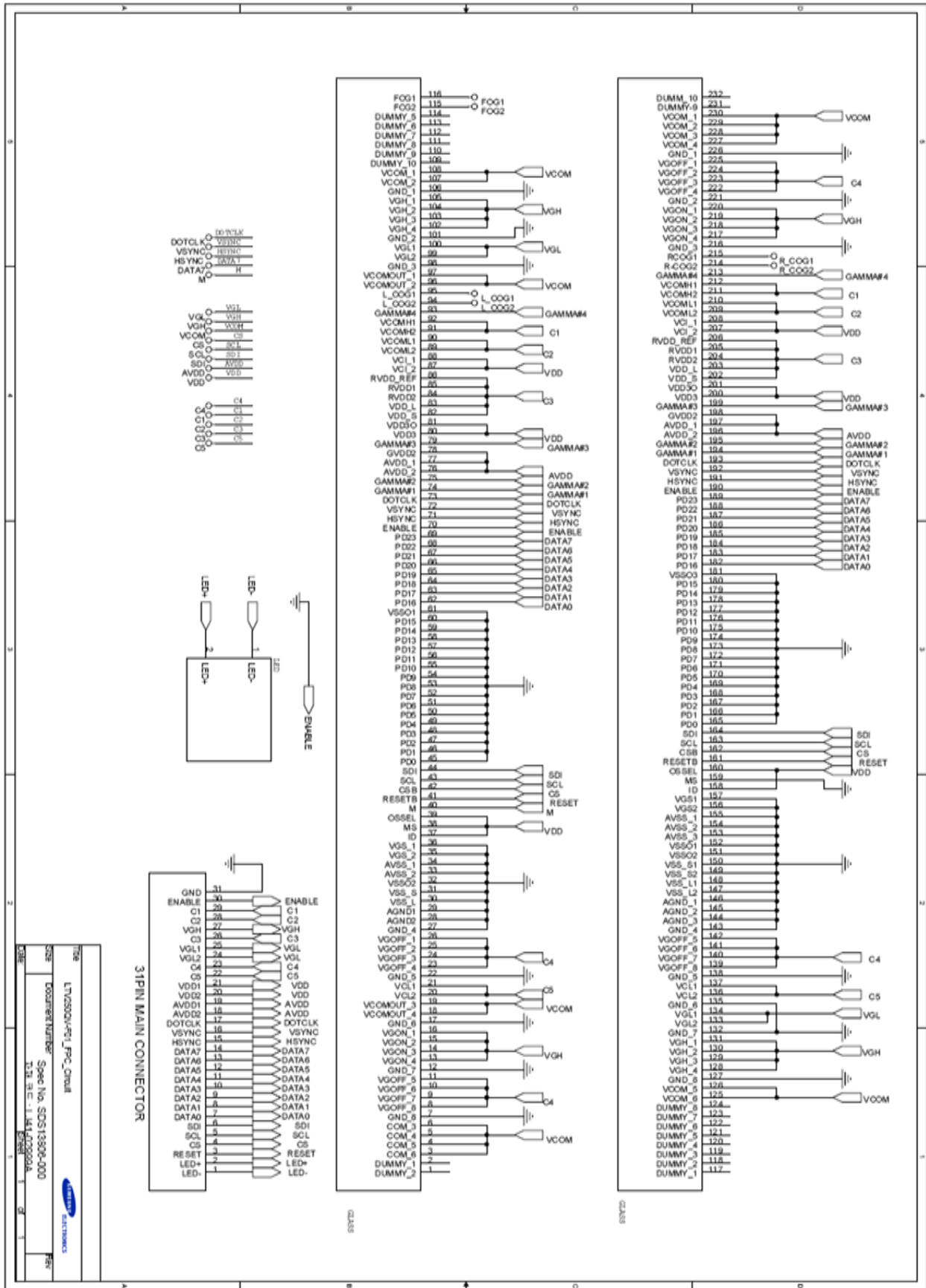

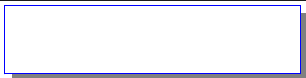

# 12. Out Dimension

**Top View Dimensions:**  
 Total width: 53.58mm (2.111in) ±0.05mm  
 Total height: 28.20mm (1.110in) ±0.05mm  
 Pin pitch: 2.54mm (0.100in)  
 Pin diameter: 0.5mm (0.020in) ±0.02mm  
 Pin length: 2.54mm (0.100in) ±0.05mm

**Side View Dimensions:**  
 Total height: 2.54mm (0.100in) ±0.05mm  
 Pin diameter: 0.5mm (0.020in) ±0.02mm

**Detail View Dimensions:**  
 Pin diameter: 0.5mm (0.020in) ±0.02mm  
 Pin length: 2.54mm (0.100in) ±0.05mm  
 Pin thickness: 0.25mm (0.010in) ±0.01mm  
 Pin width: 1.27mm (0.050in) ±0.02mm  
 Pin spacing: 2.54mm (0.100in) ±0.05mm  
 Pin offset: 0.25mm (0.010in) ±0.01mm  
 Pin angle: 45°

**Material and Surface:**  
 Body: 30% Ni/Au  
 Leads: 40% Ni/Au (max)  
 Leads: 47% Sn/Au (min)

**Notes:**  
 1. Body Area is 2.50 mm<sup>2</sup> (0.097 in<sup>2</sup>)  
 2. Lead Area is 2.50 mm<sup>2</sup> (0.097 in<sup>2</sup>)  
 3. Total Area is 5.00 mm<sup>2</sup> (0.194 in<sup>2</sup>)

**GENERAL TOLERANCE**

STEP	LEVEL 1	LEVEL 2	LEVEL 3
0 < X < 4	±0.05	±0.1	±0.2
4 < X < 16	±0.08	±0.15	±0.3
16 < X < 64	±0.12	±0.25	±0.5
64 < X < 256	±0.25	±0.4	±0.8

**REVISION TABLE**

REV	DATE	DESCRIPTION OF REVISION	MODEL NAME	REASON	DATE 0.81
1	10/11/11	INITIAL	LTV250QV-F01	Outline Dimension	10/11/11

**PRELIMINARY**

NO	PART NAME	CODE NO	SPECIFICATION	Q'TY	SPEC NO	REMARK

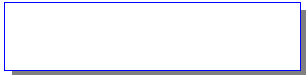

### 13. Packing

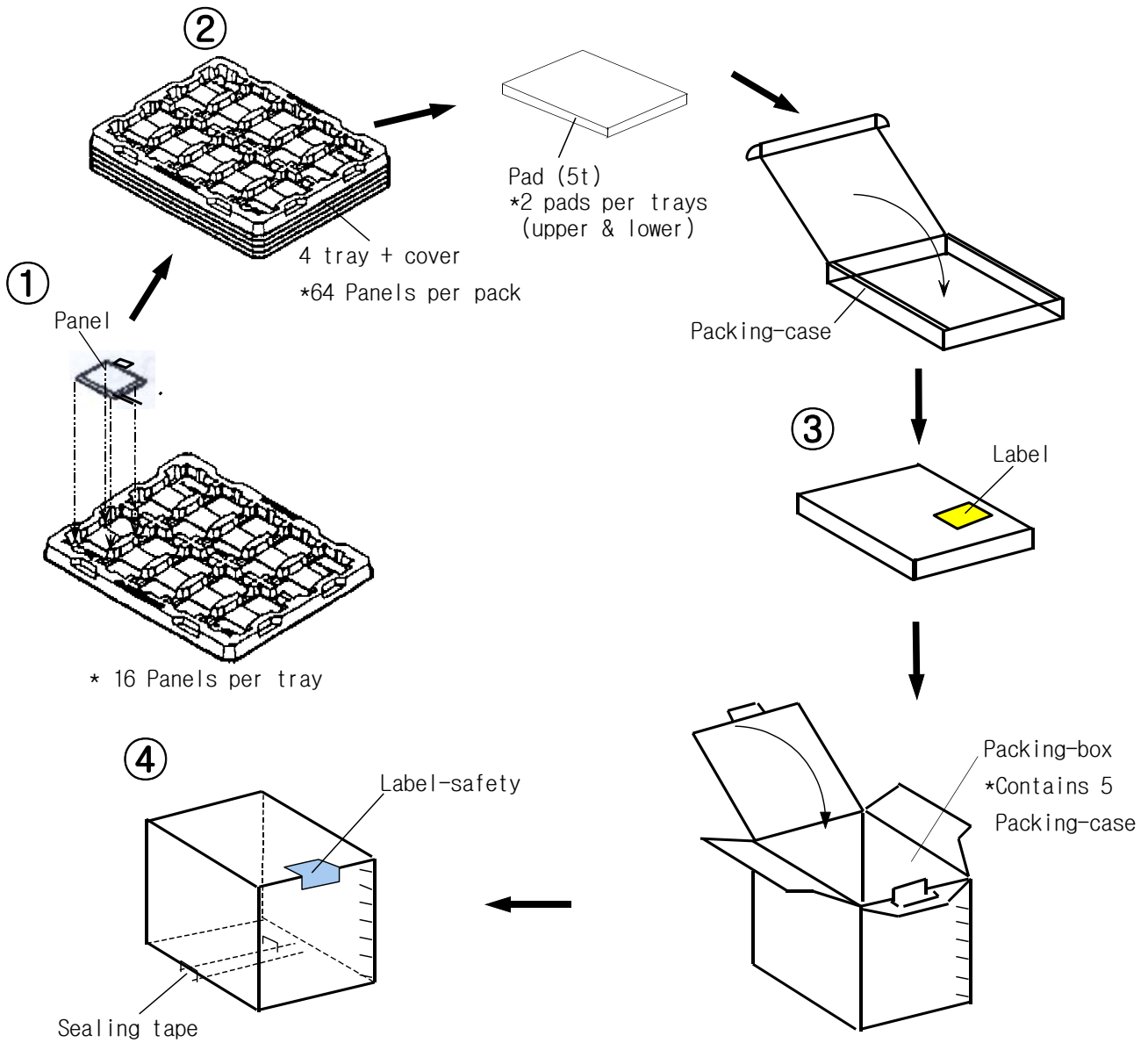

Note (1) Total : Case: Approx. 2.39 Kg

Box: Approx. 12.65 Kg

(2) Size : Case: 490(W) x 342(D) x 58(H)

Box: 505(W) x 355(D) x 312(H)

(3) Place the panels in the tray facing the direction shown in the figure.

(4) Place 5 tray and cover(empty tray) and pads inside the packing-case.

(5) Place 5 packing-case inside the packing-box.(Affix the label)

(6) Seal the packing-box. Affix the label-safety.

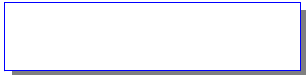

# 14. Marking & Others

(1) Packing case attach

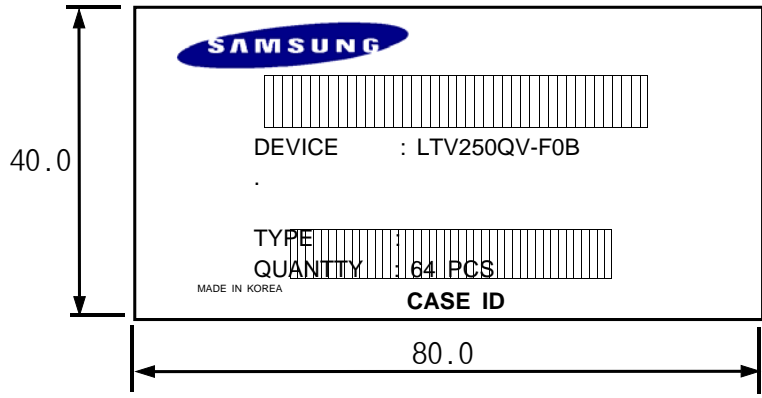

**CASE ID : V 00 00 00001**

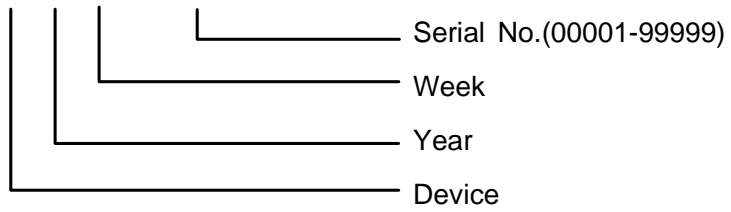

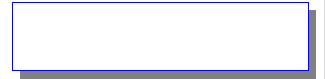

## 15. General Precautions

### 15.1 Handling

- (a) When the module is assembled, it should be attached to the system firmly. Be careful not to twist and bend the module.
- (b) Refrain from strong mechanical shock and / or any force to the module. In addition to damage, this may cause improper operation or damage to the module and back-light unit.
- (c) Note that polarizers are very fragile and could be easily damaged. Do not press or scratch the surface harder than a HB pencil lead.
- (d) Wipe off water droplets or oil immediately. If you leave the droplets for a long time, Staining and discoloration may occur.
- (e) If the surface of the polarizer is dirty, clean it using some absorbent cotton or soft cloth.
- (f) The desirable cleaners are water, IPA(Isopropyl Alcohol) or Hexane. Do not use Ketone type materials(ex. Acetone), Ethyl alcohol, Toluene, Ethyl acid or Methyl chloride. It might permanent damage to the polarizer due to chemical reaction.
- (g) If the liquid crystal material leaks from the panel, it should be kept away from the eyes or mouth. In case of contact with hands, legs or clothes, it must be washed away thoroughly with soap.
- (h) Protect the module from static , it may cause damage to the Integrated Gate Circuit.
- (i) Use finger-stalls with soft gloves in order to keep display clean during the incoming inspection and assembly process.
- (j) Do not disassemble the module.
- (k) Protection film for polarizer on the module shall be slowly peeled off just before use so that the electrostatic charge can be minimized.
- (l) Pins of I/F connector shall not be touched directly with bare hands

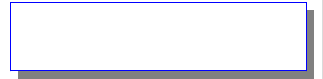

## 15.2 Storage

- (a) Do not leave the panel in high temperature, and high humidity for a long time. It is highly recommended to store the module with temperature from 0 to 35°C and relative humidity of less than 70%.
- (b) Do not store the TFT-LCD module in direct sunlight.
- (c) The module shall be stored in a dark place. It is prohibited to apply sunlight or fluorescent light during the store.

## 15.3 Operation

- (a) Do not connect, disconnect the module in the "Power On" condition.
- (b) Power supply should always be turned on/off by the "Power on/off sequence"

## 15.4 Others

- (a) The Liquid crystal is deteriorated by ultraviolet, do not leave it in direct sunlight and strong ultraviolet ray for many hours.
- (b) Avoid condensation of water. It may result in improper operation or disconnection of electrode.
- (c) Do not exceed the absolute maximum rating value. ( the supply voltage variation, input voltage variation, variation in part contents and environmental temperature, and so on) Otherwise the panel may be damaged.
- (d) If the panel displays the same pattern continuously for a long period of time, it can be the situation when the image "Sticks" to the screen.
- (e) This panel has its circuitry FPC on the bottom side and should be handled carefully in order not to be stressed.